



# HARDWARE GUIDE

## Chiller Controller C1050 Series

---

Specifications and Operational Guide

---

[www.proloncontrols.com](http://www.proloncontrols.com) | [info@proloncontrols.com](mailto:info@proloncontrols.com)  
17 510, rue Charles, Suite 100, Mirabel, QC, J7J 1X9



# Table of Contents

<b>General Information .....</b>	<b>4</b>
PL-C1050 Chiller Controller .....	4
Description.....	4
General Behaviour .....	4
<b>Operating Sequence .....</b>	<b>5</b>
Pumps.....	5
Water Supply Setpoint .....	5
Chiller Stages.....	5
<b>Components .....</b>	<b>6</b>
Component Identification.....	6
LEDs.....	7
Address Configuration for Networking .....	7
Input and Output Identification.....	8
<b>Inputs.....</b>	<b>9</b>
Analog Input.....	9
Temperature Sensors.....	9
Proof of Pump .....	10
<b>Outputs.....</b>	<b>11</b>
Output Specifications.....	11
Configuration of Digital Outputs.....	11
Typical Connection of Digital Outputs .....	12
Typical Connection of the Analog Output.....	13
<b>Power Source / Network .....</b>	<b>14</b>
Power Source.....	14
Network Communication.....	14
<b>Technical Specifications .....</b>	<b>15</b>
<b>Compliance.....</b>	<b>16</b>
FCC User Information.....	16
Industry Canada .....	16
<b>Overall Dimensions .....</b>	<b>17</b>



## Table of Figures

Figure 1 - Component Identification .....	6
Figure 2 - LEDs Identification .....	7
Figure 3 - Addressing Dipswitches .....	7
Figure 4 - Input and Output Identification.....	8
Figure 5 - Analog input .....	9
Figure 6 - Connecting the Temperature Sensors .....	9
Figure 7 - Connecting the Proof of Pump Contacts to the Controller .....	10
Figure 8 - Output in SOURCE mode .....	11
Figure 9 - Output in SINK mode .....	12
Figure 10 - Connection of Active Outputs 3 and 4 .....	12
Figure 11 - Connection of Passive Output 3 and 4 .....	12
Figure 12 - Connecting the Analog Output (Controller Powered) .....	13
Figure 13 - Connecting the Analog Output (External Power) .....	13
Figure 14 - Connecting the 24VAC Power Source .....	14
Figure 15 - Connecting to the Network .....	14
Figure 16 - C1050 Size Diagram .....	17



## PL-C1050 Chiller Controller

### Description

The Prolon PL-C1050 Chiller Controller is a microprocessor-based controller designed to operate chiller equipment (AIR COOLED and WATER COOLED chillers) with up to three stages, as well the associated system pumps. It features a variety of control strategies, including outside 4 temperature reset scales, lead-lag sequences, pump exercise intervals and more.

### General Behaviour

The Prolon C1050 Chiller controller monitors dedicated inputs and uses pre-established control sequences that drive dedicated outputs to control standard Chiller equipment. The main goal of this controller is to regulate the chilled water supply temperature. Numerous configurable parameters and sequences allow for the fine tuning of the pumps, chillers stages, target supply temperature and a whole range of safeguards. The various programming options allow the user to incorporate lead-lag sequences into the pumps and chiller stages, specify conditions for pump activity as well as apply schedules and limits. All these parameters can be accessed and modified using the Prolon Focus software.

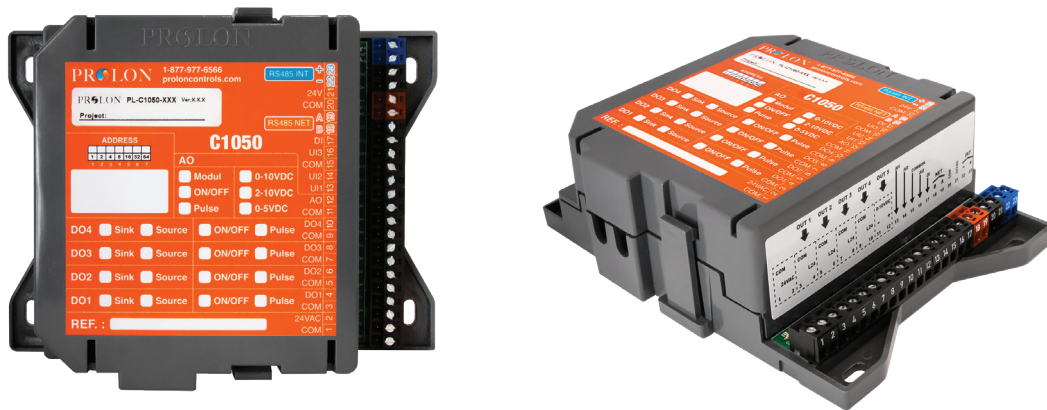



## Operating Sequence

### **Pumps**

---

The PL-C1050 Chiller Controller can control systems with one or two pumps. The dual pump sequence is intended for hydronic systems where there is a secondary pump that acts as a backup to the primary pump, with both pumps being installed in parallel. Primary pump activity is based either on a schedule or on the outside air temperature, or both. The secondary pump, when required, will only be activated when there is no proof of operation of the primary pump after a configurable delay. The pumps can be setup for various lead-lag sequences wherein they will alternate between primary and secondary roles. The pumps can also be exercised after configurable periods of inactivity. Note that the chiller stages require proof of pump to activate. Alternatively, pump control can be entirely disabled, and the chillers can run without concern of pump status.

### **Water Supply Setpoint**

---

The target water supply temperature can be a simple fixed setpoint, or instead follow a reset scale based on outside temperature, return water temperature, or even on a network provided cooling demand (which usually represents an average cooling request coming from zones in the building). All scales and setpoints are fully configurable for any of the methods used above.

### **Chiller Stages**

---

Chiller activation is based on a call for cooling, which occurs when the supply temperature rises above the setpoint by a configurable margin. The PL-C1050 Chiller controller can be configured to control up to three chiller stages in various combinations (ex.: a single chiller with three stages, two single-stage chillers, etc.). For water cooled chillers, chiller activity can be interlocked based on the entering condenser water temperature. Upon detection of multiple sequential faults, a lockout mode can be setup to block further chiller activity until a manual intervention occurs. The chiller outputs can also be set up for various lead-lag sequences to ensure an even distribution of the workload.



## Component Identification

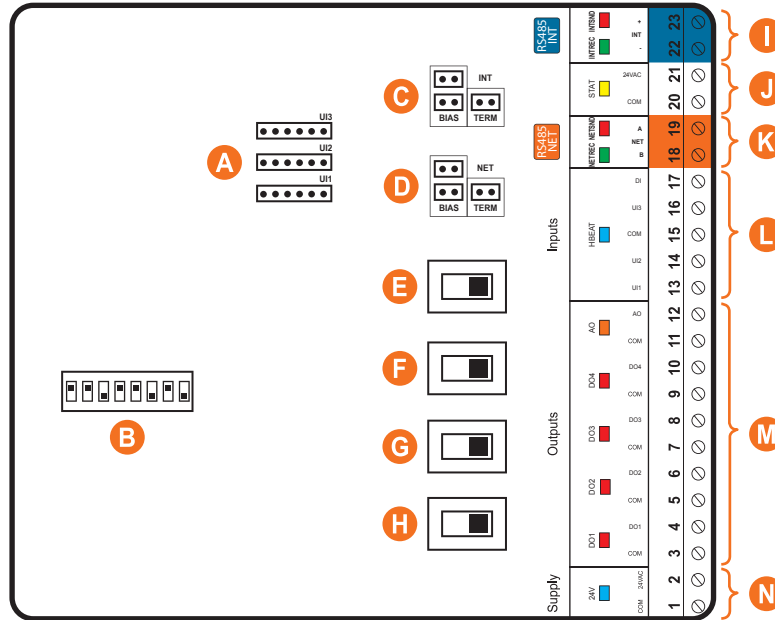

Figure 1 - Component Identification

### Legend:

- A** - Analog Input Signal Mode Jumpers
- B** - Addressing dipswitch
- C** - Jumpers for terminating and bias resistors for the INT port (see **I**)
- D** - Jumpers for terminating and bias resistors for the NET port (see **K**)
- E** - SOURCE/SINK dipswitch for Output 4
- F** - SOURCE/SINK dipswitch for Output 3
- G** - SOURCE/SINK dipswitch for Output 2
- H** - SOURCE/SINK dipswitch for Output 1
- I** - INT port for RS485 communication (terminal block)
- J** - Alternate terminal blocks for 24 VAC (provides power to an optional digital sensor)
- K** - NET port for RS485 communication (terminal block)
- L** - Inputs (4 total)
- M** - Terminal Blocks for Outputs 1 to 5
- N** - Terminal Blocks for 24 VAC



## LEDs

The C1050 has various LEDs which are linked to different functions and outputs of the controller. Each LED is individually identified to help the user make a quick visual diagnostic of the controller's activity and status.

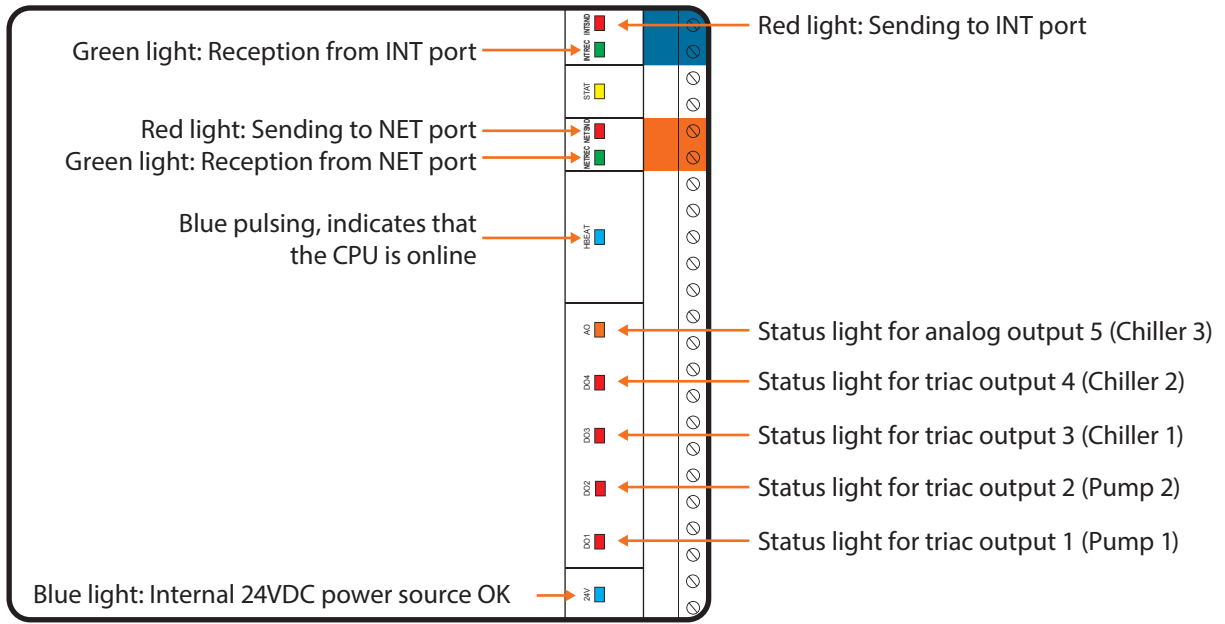

Figure 2 - LEDs Identification

## Address Configuration for Networking

A unique address on each controller must be configured by setting the first 7 switches on the addressing dipswitch to the desired value.

These switches are numbered from 1 to 7 and represent a binary value from 1 to 64 (1, 2, 4, 8, 16, 32, 64 respectively). The value of each switch that is in the ON position is added together to form the numerical address of the controller.

The example on Figure 3 shows the switches 1, 2 and 4 on the ON position. So the corresponding values are 1, 2 and 8, giving an address sum of 11. ( $1+2+8=11$ )

The Proton network allows a maximum of 127 addresses, therefore 127 controllers.

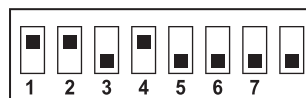

Figure 3 - Addressing Dipswitches



## Input and Output Identification

All the inputs and outputs of the C1050 use pluggable screw type terminal blocks with elevator style clamping, which make connections easier and more secure.

The C1050 Chiller Controller has two separate communication ports offering the same functionality on each. Both act as ports for incoming Modbus communications from other Proton devices or interfaces, such as a Network Controller or remote computer with Proton Focus software.

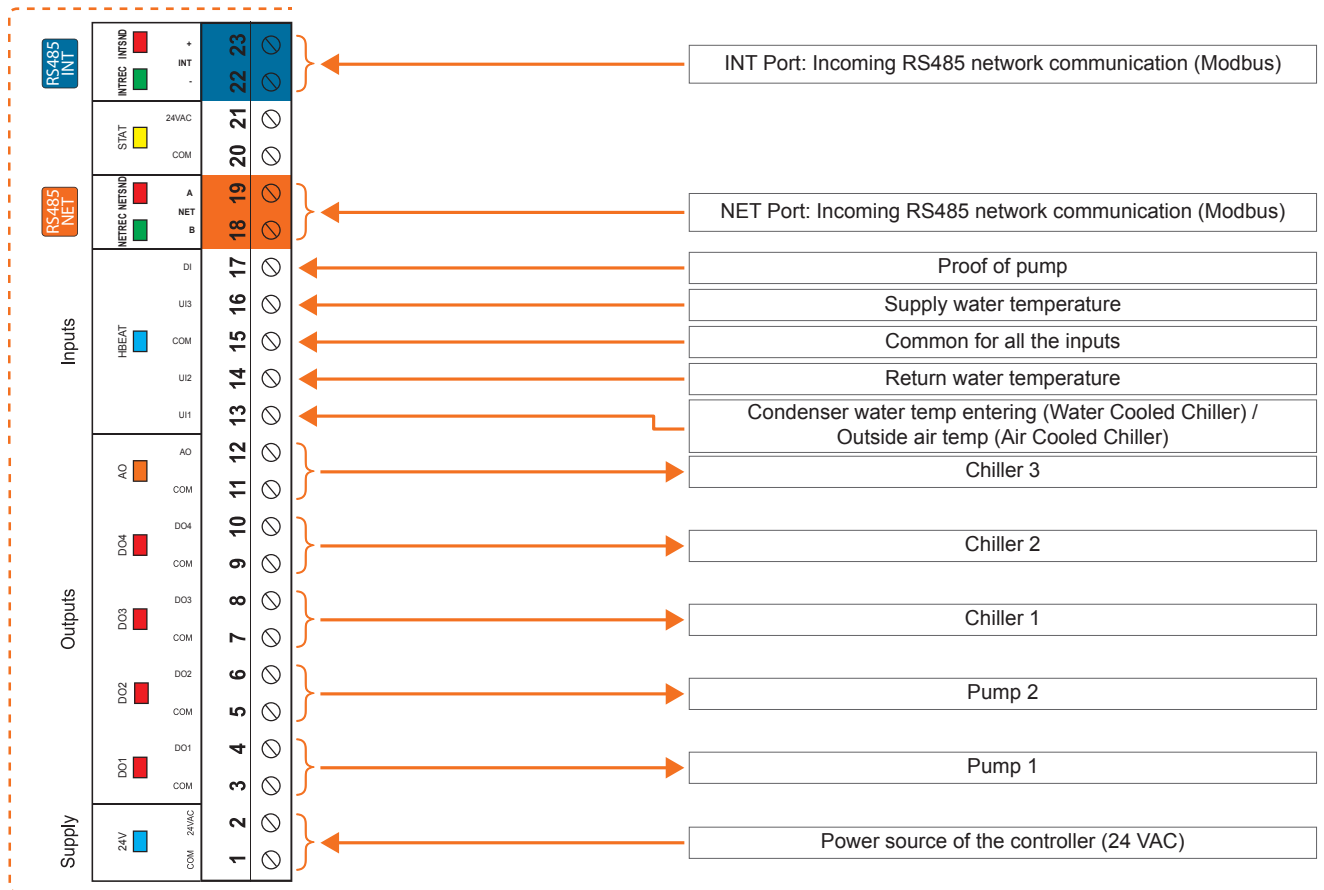

Figure 4 - Input and Output Identification





# Inputs

## Analog Input

The C1050 series controllers are equipped with three general purpose analog inputs. These inputs can be configured to receive signals of the following types:

- Thermistor ( $\Omega$ )
- 0-5V
- 4-20mA
- 0-10V

When a thermistor is used, the thermistor must be 10K $\Omega$  TYPE 3.

Each C1050 analog input is equipped with a fast-switching barrier diode to protect against surges and short circuits.

By default, the C1050-CHL analog inputs are set up for thermistor mode. The input signal mode can be changed by setting jumpers U1, U2 and U3, situated inside the casing, in the desired position:

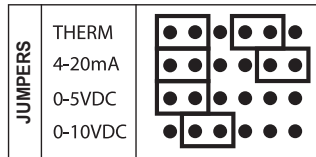

Figure 5 - Analog input

## Temperature Sensors

The C1050 Chiller Controller has three analog inputs to monitor various temperature readings, including supply water, return water and entering condenser water (ECWT) or outside air temperature (OAT), whether the chiller is water cooled or air cooled. The sensors used are standard 10k type 3 thermistors that share a single common connection (see Figure 6).

Note that the outside air temperature can be provided by an alternate source on the network. If a network controller is present on the network, it can retrieve the outside temperature reading from one controller and distribute it to any other controllers on the network.

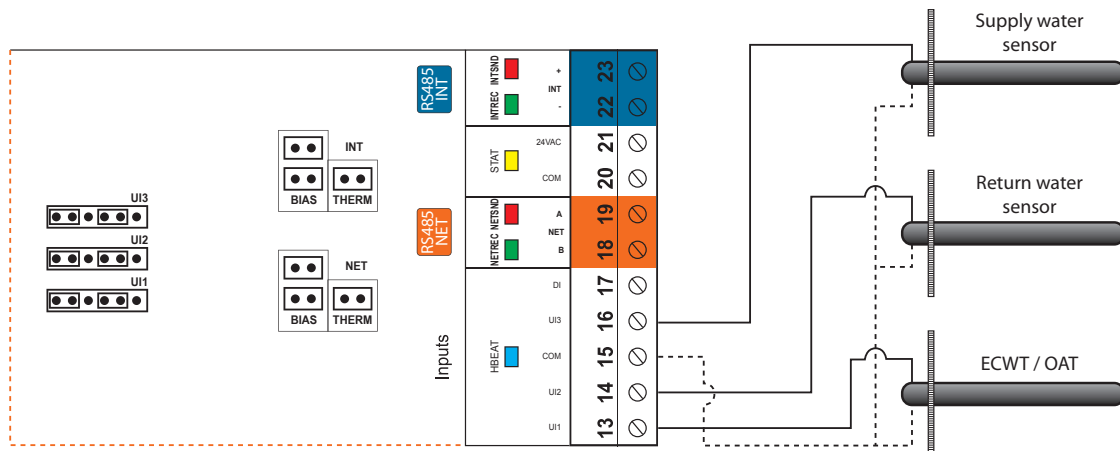
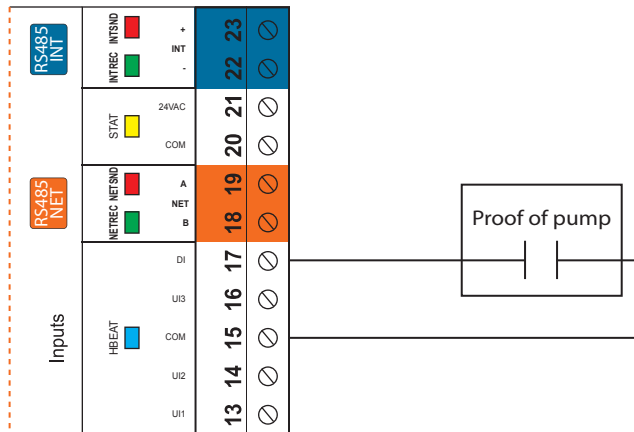

Figure 6 - Connecting the Temperature Sensors



## Proof of Pump

The C1050 has one digital input dedicated to the proof of pump signals. Please refer to Figure 7 see how to correctly connect it. To indicate proof of pump, the contact must be closed. If no proof of pump signal is available, you must short the corresponding input, or else the controller will interpret the absence of signal as a pump malfunction and no cooling action will be taken.



**Figure 7 - Connecting the Proof of Pump Contacts to the Controller**



# Outputs

The C1050 Chiller controller contains 5 customizable outputs; four triac ON/OFF outputs (24VAC) and one analog output (0-10VDC). Output configuration is performed via the Proton Focus software.

An integrated resettable fuse protects each of the outputs of the C1050 against current surges and short circuits. This protection will cut the current to the output as soon as an overload condition is detected. The fuse is round and yellow-colored which, upon a short circuit condition, will heat up and change to orange. When the faulty wiring or circuit is fixed, the fuse will automatically reset and allow current to flow through the output again.

## Output Specifications

Output	Type	Action	Applications
<b>DO 1</b>	Triac Source 24VAC Max Current: 300 mA	On-or-Off	Pump Stage 1
<b>DO 2</b>	Triac Source 24VAC Max Current: 300 mA	On-or-Off	Pump Stage 2
<b>DO 3</b>	Triac Source 24VAC Max Current: 300 mA	On-or-Off	Chiller Stage 1
<b>DO 4</b>	Triac Source 24VAC Max Current: 300 mA	On-or-Off	Chiller Stage 2
<b>AO 1</b>	Configurable Analog Output: - 0 to 10 VDC Max Current: 40 mA	On-or-Off	Chiller Stage 3

## Configuration of Digital Outputs

The digital triac outputs are configurable (SOURCE/SINK) via a switch located on the board. Simply move the switch to obtain either a SOURCE active output (1) or a SINK passive output (2).

1) Switch position to obtain a SOURCE **active output**:

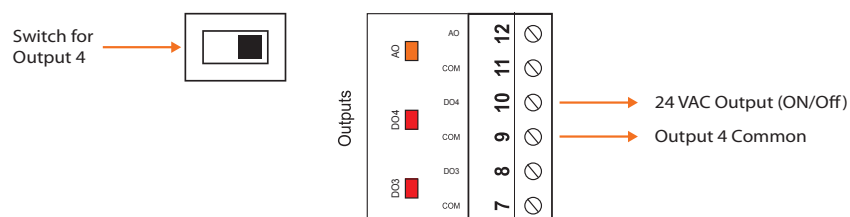

Figure 8 - Output in SOURCE mode



2) Switch position to obtain a SINK *passive output*:

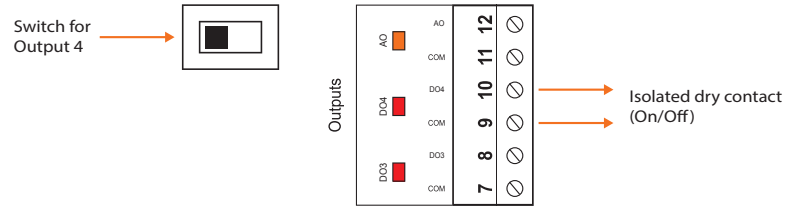

Figure 9 - Output in SINK mode

## Typical Connection of Digital Outputs

Two types of configurations are possible:

1) Active output (SOURCE). The C1050 is actively powering the load:

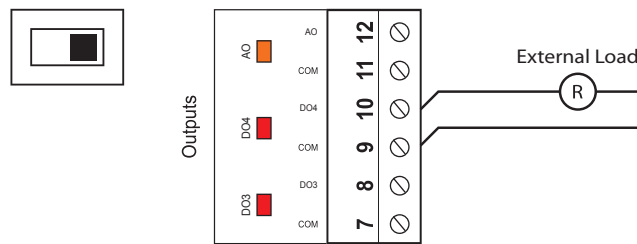

Figure 10 - Connection of Active Outputs 3 and 4

2) Passive output (SINK). The C1050 opens and closes a contact to allow an external source to power the load:

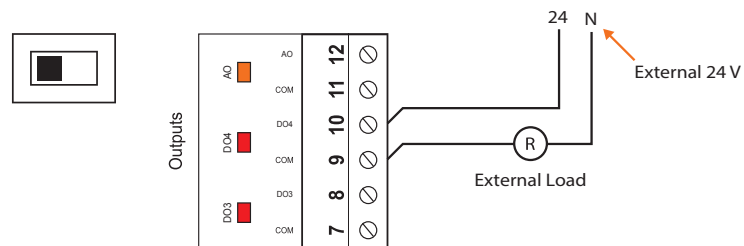

Figure 11 - Connection of Passive Output 3 and 4



## Typical Connection of the Analog Output

Two types of configuration are possible:

- 1) The C1050 powers the load and provides a control signal:

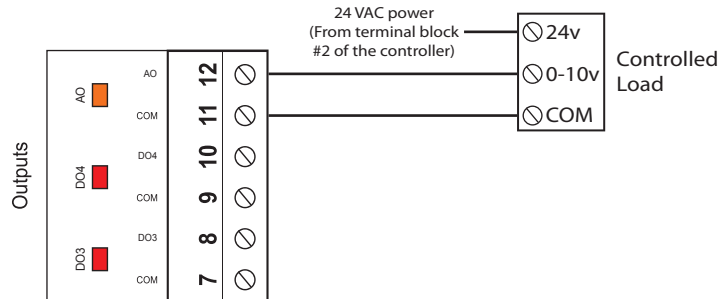

**Figure 12 - Connecting the Analog Output (Controller Powered)**

- 2) The C1050 only provides the control signal to the load, which is powered by an external source:

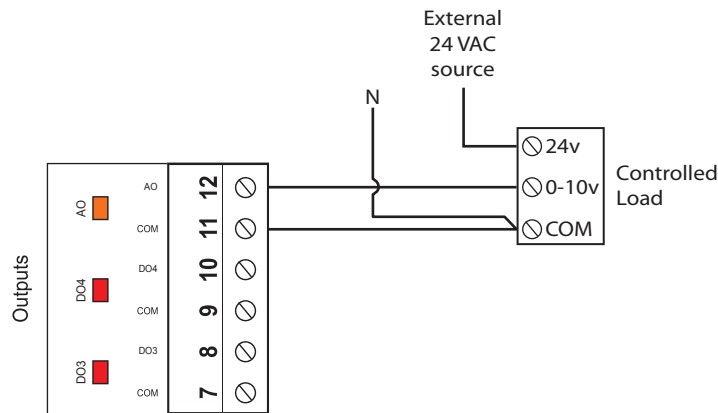

**Figure 13 - Connecting the Analog Output (External Power)**



## Power Source

The Proton C1050 controller is powered by a 24 VAC power source connected using the "COM" terminal and the "24 VAC" terminal (see Figure 14). The common for all inputs and outputs are the same as the power source's common (exception: when an output is set to passive, the common for this output will not correspond to the power source common). All output power sources also originate from the controller's power source.

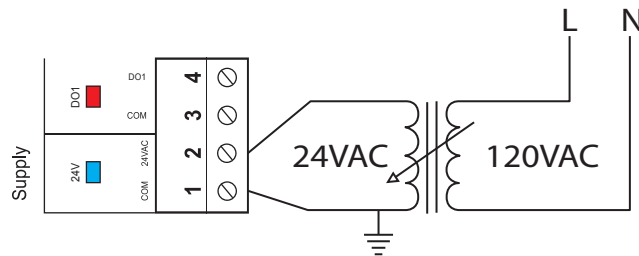

Figure 14 - Connecting the 24VAC Power Source

## Network Communication

The Proton C1050 controller works autonomously or networked. When networked, it will communicate in real-time with other controllers. The C1050 controller's default communication protocol is Modbus RTU over RS485. The addressing is done with the addressing dipswitch located on the C1050 card (see Figure 3). The network connections are made using the NET terminal block located on the Proton C1050 controller (see Figure 15).

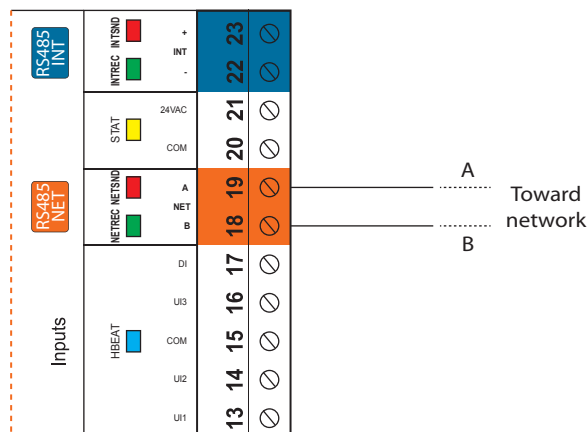

Figure 15 - Connecting to the Network



## Technical Specifications

**Supply:** 24 VAC  $\pm$ 10%, 50/60 Hz, Class 2

**Consumption:** 2 VA (Consumption), 32 VA (Input)

**Inputs:** Entering Condenser Water / Outside air temperature – 10K thermistor  
Return Water – 10 K thermistor  
Supply Water – 10 K thermistor  
Proof of pump – Dry Contact

**Digital outputs:** 4 triac outputs, 10-30 VAC source or sink, 300 mA max (resettable fuse)

**Analog output:** 1 output 0-10 VDC / 2-10 VDC / 0-5 VDC, 40 mA max (resettable fuse) for the valve

**Indication lights (LED):** State of each output / Communication / Supply / State of microprocessor

**Microprocessor:** PIC18F6722, 8 bits, 40 MHz, 128KB FLASH memory

**Casing:** Molded ABS, UL94-HB

**Communication:** Modbus RTU (RS485), up to 127 nodes

**Baud rate:** 9600, 19200, 38400, 57600, 76800, 115200

**Connection:** Removable screw-type terminal blocks (16 AWG max)

**Dimensions:** 6.2" x 5.2" x 2.5" (157 mm x 132 mm x 64 mm)

**Weight:** 0.85 lbs (0.39 kg)

**Environment:** -4 to 122 °F (-20 to 50 °C) Non-Condensing

**Certification:** UL916 Energy Management Equipment, CAN/CSA-C22.2, RoHS, FCC part 15: 2012 class B

*The performance specifications are nominal and conform to acceptable industry standards. Prolon Inc. will not be liable for damages resulting from misapplication or misuse of its products.*



## Compliance

- FCC Compliant to CFR47, Part 15, Subpart B, Class B
- Industry Canada (IC) Compliant to ICES-003, Issue 5: CAN ICES-3 (B)/NMB-3(B)
- RoHS Directive (2002/95/EC)

### FCC User Information

---

This device complies with Part 15 of the FCC Rules. Operation is subject to the following two conditions: (1) this device may not cause harmful interference, and (2) this device must accept any interference received, including interference that may cause undesired operation.

**Caution:** Any changes or modifications not approved by Proton can void the user's authority to operate the equipment.

**Note:** This equipment has been tested and found to comply with the limits for a Class B digital device, pursuant to part 15 of the FCC Rules. These limits are designed to provide reasonable protection against harmful interference in a residential installation. This equipment generates, uses and can radiate radio frequency energy and, if not installed and used in accordance with the instructions, may cause harmful interference to radio communications. However, there is no guarantee that interference will not occur in a particular installation. If this equipment does cause harmful interference to radio or television reception, which can be determined by turning the equipment off and on, the user is encouraged to try to correct the interference by one or more of the following measures:

- Reorient or relocate the receiving antenna.
- Increase the separation between the equipment and receiver.
- Connect the equipment into an outlet on a circuit different from that to which the receiver is connected.
- Consult the dealer or an experienced radio/TV technician for help.

### Industry Canada

---

This Class (B) digital apparatus meets all the requirements of the Canadian Interference-Causing Equipment regulations.

Cet appareil numérique de la Classe (B) respecte toutes les exigences du Règlement sur le matériel brouilleur du Canada.





# Overall Dimensions

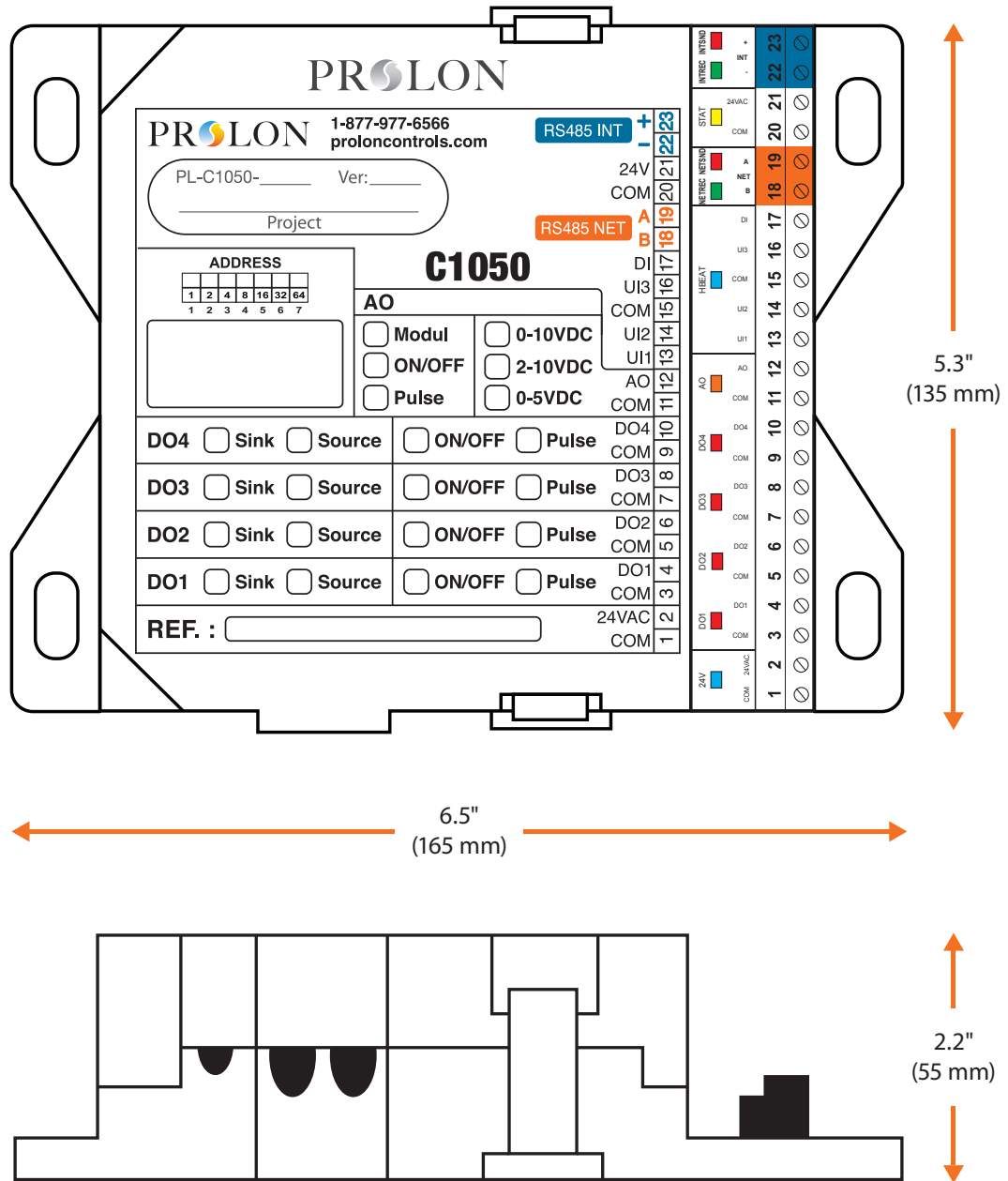

Figure 16 - C1050 Size Diagram

REV. 7.3.4

PL-HRDW-CHL-C1050-C/F-EN

© Copyright 2023 Prolon. All rights reserved.

No part of this document may be photocopied or reproduced by any means, or translated to another language without prior written consent of Prolon. All specifications are nominal and may change as design improvements are introduced. Prolon shall not be liable for damages resulting from misapplication or misuse of its products. All trademarks are the property of their respective owners.